



**QUICK START EN 125 A - 630 A**

# ATyS g

**Motorised Source Changeover Switch  
Automatic Transfer Switching Equipment**

## Preliminary operations

Check the following upon delivery and after removal of the packaging:

- Packaging and contents are in good condition
- The product reference corresponds to the order
- Contents should include:
  - Qty 1 x ATyS g
  - Qty 1 x Emergency handle and fixing clip
  - Quick Start instruction sheet

## Warning

**⚠ Risk of electrocution, burns or injury to persons and / or damage to equipment.**

This Quick Start is intended for personnel trained in the installation and commissioning of this product. For further details refer to the product instruction manual available on the SOCOMECE website.

- This product must always be installed and commissioned by qualified and approved personnel.
- Maintenance and servicing operations should be performed by trained and authorised personnel.
- Do not handle any control or power cables connected to the product when voltage may be, or may become present on the product, directly through the mains or indirectly through external circuits.
- Always use an appropriate voltage detection device to confirm the absence of voltage.
- Ensure that no metal objects are allowed to fall in the cabinet (risk of electrical arcing).

- For 125 - 160 A (Uimp = 8 kV). Terminations must respect a minimum of 8 mm clearance from live parts to parts intended to be earthed and between poles.
- For 200 - 630 A (Uimp = 12 kV). Terminations must respect a minimum of 14 mm clearance from live parts to parts intended to be earthed and between poles.

Failure to observe good engineering practises as well as to follow these safety instructions may expose the user and others to serious injury or death.

**⚠ Risk of damaging the device**  
In case the product is dropped or damaged in any way it is recommended to replace the complete product.

## Accessories

- Bridging bars and connection kits.
- Control voltage transformer (400 VAC → 230 VAC).
- DC power supply (12/24 VDC → 230 VAC).
- Phase barriers.
- Terminal shrouds.
- Terminal screens.
- Auxiliary contacts (Additional).
- Padlocking in 3 positions (I - 0 - II).
- Lockout accessories (RONIS - EL 11 AP).
- Door escutcheon frame.
- ATyS D10 Interface (remote display).
- Voltage sensing kit.
- Sealable cover.
- RJ45 cable for ATyS D10.
- Plug-in optional Modbus RS485 communication module.

For further details refer to the product instruction manual under chapter "Spares and Accessories".



[www.socomec.com](http://www.socomec.com)  
To download, brochures, catalogues and technical manuals:  
[https://www.socomec.com/range-automatic-transfer-switches\\_en.html?product=/atys-t-atys-g\\_en.html](https://www.socomec.com/range-automatic-transfer-switches_en.html?product=/atys-t-atys-g_en.html)

## Installation and Commissioning

**STEP 1**  
Cabinet / Back Plate Installation

**STEP 2**  
Power Terminal Connections

**STEP 3**  
COMMAND / CONTROL terminal connections

**STEP 4**  
Power SUPPLY and ATS Controller Terminal Connections

**STEP 5**  
CHECK

**STEP 6**  
PROGRAMMING

**STEP 7A**  
AUT Mode  
(Automatic Control)

**STEP 7B**  
AUT Mode  
(Remote Control)

**STEP 7C**  
Manual Mode

**STEP 7D**  
Padlocking Mode

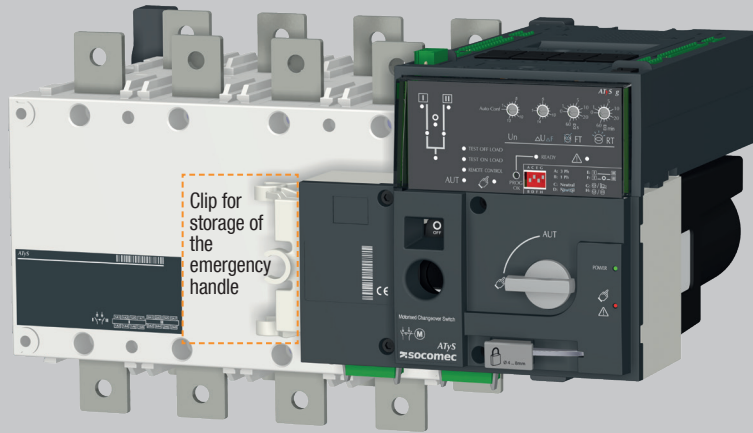

## STEP 1 Installation

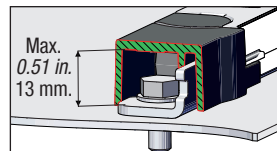
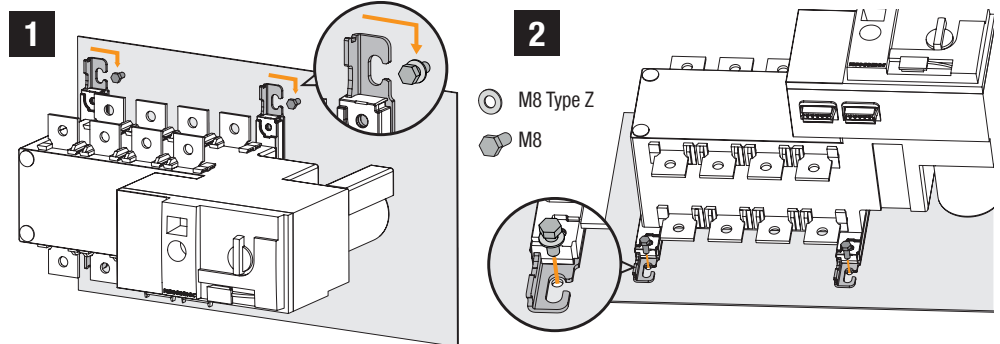

**⚠ Caution:** ensure that the product is installed on a flat rigid surface.

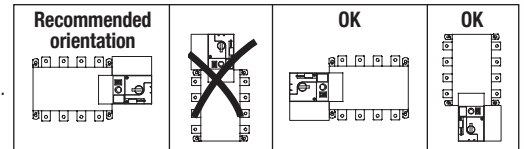

## 3 Mounting

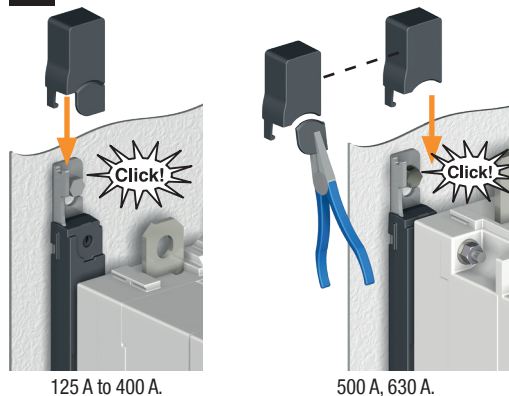

## Removing covers

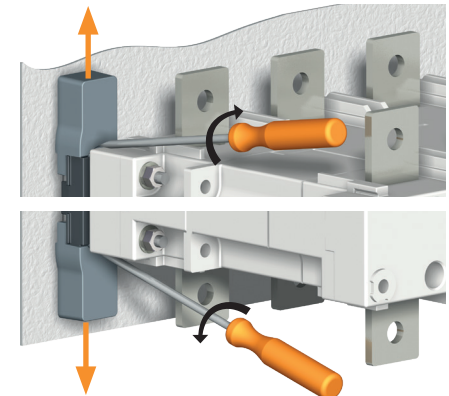

## STEP 2 Power Terminal Connections

To be connected using terminal lugs, rigid or flexible busbars.

	FRAME B3			FRAME B4			FRAME B5	
	125 A	160 A	200 A	250 A	315 A	400 A	500 A	630 A
Minimum cable section Cu (mm <sup>2</sup> )	35	35	50	95	120	185	2x95	2x120
Recommended Cu busbar cross-section (mm <sup>2</sup> )	-	-	-	-	-	-	2x32x5	2x40x5
Maximum Cu cable cross-section (mm <sup>2</sup> )	50	95	120	150	240	240	2x185	2x300
Maximum Cu busbar width (mm)	25	25	25	32	32	32	50	50
Type of screw	M8	M8	M8	M10	M10	M10	M12	M12
Recommended tightening torque (lb.in/N.m)	73.46/8.3	73.46/8.3	73.46/8.3	177.02/20	177.02/20	177.02/20	354.04/40	354.04/40
Maximum tightening torque (lb.in/N.m)	115.06/13	115.06/13	115.06/13	230.13/26	230.13/26	230.13/26	398.30/45	398.30/45

## STEP 3 CONTROL / COMMAND Terminals

Ensure that the product is in Manual Mode.

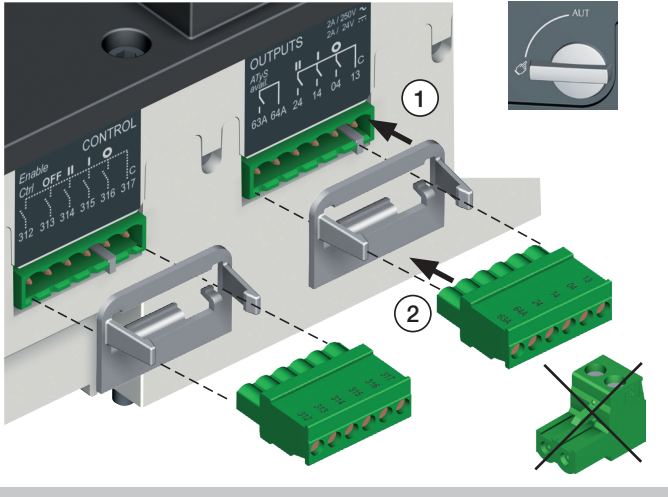

- 1 preferred source
- 2 alternate source
- 1. Position 0 order
- 2. Position 1 order
- 3. Position 2 order
- 4. Zero position priority order
- 5. Remote Control Enable (Priority over Auto)
- 6. Product Available output (Motor)
- 7. Position II aux contact
- 8. Position I aux contact
- 9. Position 0 aux contact
- 10. O/P to ATyS D10 remote display
- 11. Product Available output (ATS)
- 12. I/P Inhibition of the ATS controls
- 13. I/P Manual retransfer
- 14. S2 Stability Time Bypass: 2AT
- 15. M-G: Priority to TON / M-M: Priority enable/disable
- 16. TEST OFF LOAD Signal : TOF
- 17. M-G: Test On Load Input (TON) /M-M: Priority source selection
- 18. Not used
- 19. Contact "Start/Stop Genset" : if S1 is not available the NC contact (71-72) is close

## STEP 4A Power Supply, Sensing and Control wiring (ATyS Controller)

Example: Control wiring for a 400 VAC application having a 3 phase and neutral supply.

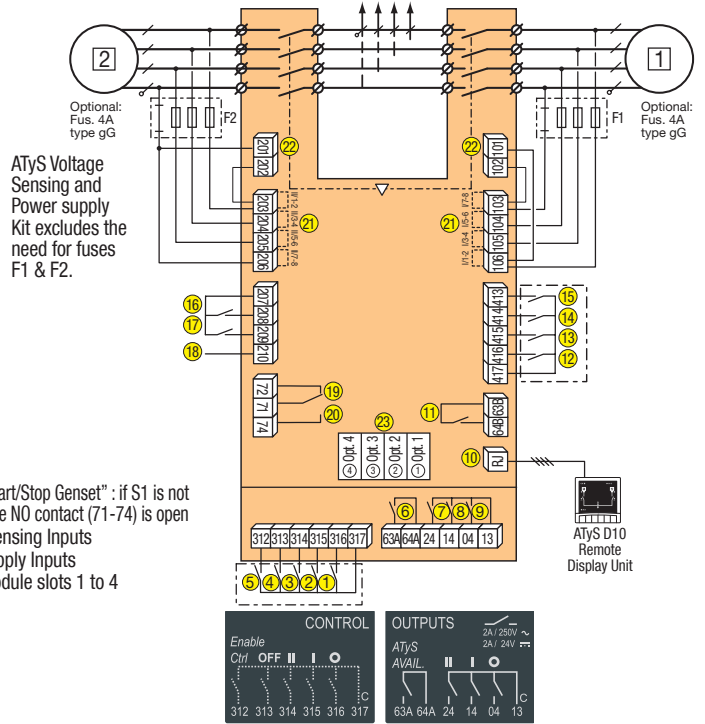

ATyS Voltage Sensing and Power supply Kit excludes the need for fuses F1 & F2.

Connect the product with a cable of section of 1,5 to 2,5 mm<sup>2</sup>.

Screw M3 - Tightening torque:  
min.: 0.5 Nm - max.: 0.6 Nm / min.: 4.43 lbin - max.: 5.31 lbin

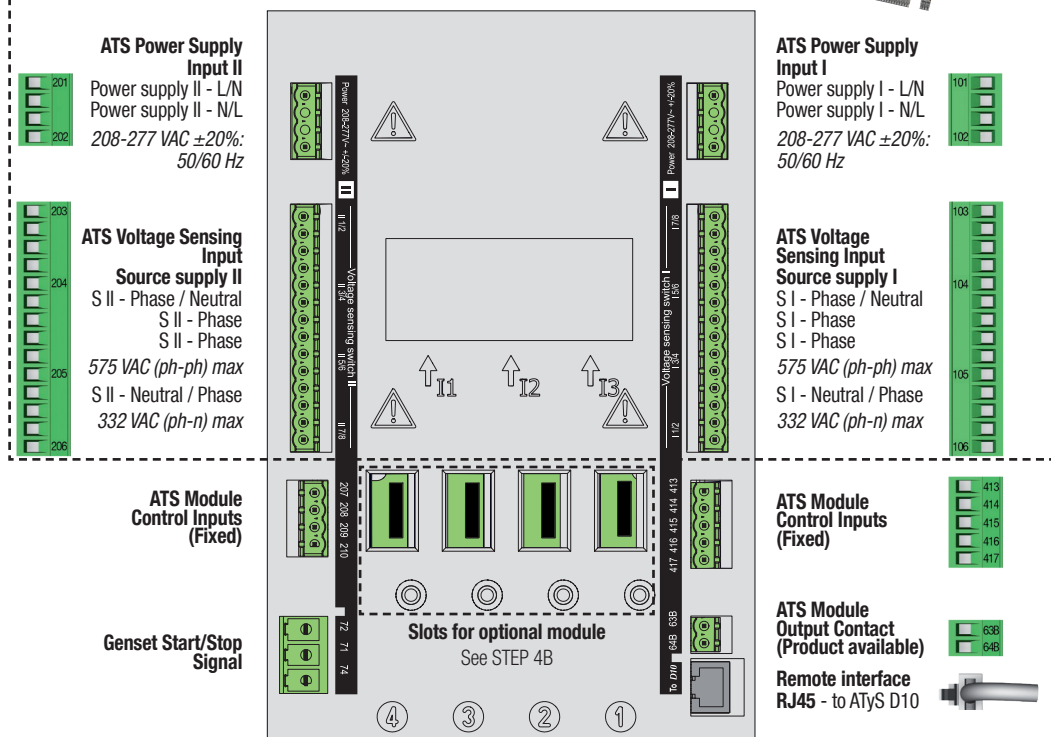
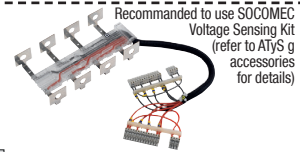

## STEP 4B Optional Module

Communication between the software and the ATyS g may be done through the Modbus RTU module which is available as an option. The MODBUS module is to be installed in one of the slots provided in the ATyS g ATS control unit. Easy Config may be installed on a PC connected through MODBUS module for a direct ATyS configuration, either isolated with possibility to create a specific configuration for a later upload and use in ATyS.

**Note:** The ATyS g may accept 1 additional MODBUS communication module. Refer to the ATyS g accessory section for details.

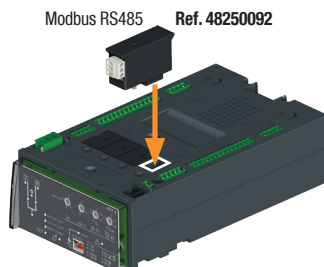

**Factory settings:**  
Address: 10  
Baud Rate: 38400  
Stop Bit: 1  
Parity: None

## STEP 5 Check

Whilst in manual mode, check the wiring and if ok power up the product.

LED "Power" Green: ON  
LED Manual/Fault Red: ON

## STEP 6 Programming the ATyS g

The ATyS g is programmed after wiring verification tests through the front of the ATS Controller in 5 steps:

**Note:** Ensure that the ATyS g is in "Manual Mode", powered and with at least one network supply available.

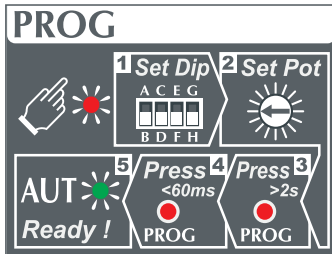

### WARNING

As a safety measure the READY LED will flash when any of the settings shown on the controller are different to those that are saved. To return to the steady READY LED revert to the saved setting values or save the displayed value by pressing the PROG OK button briefly. (This is intended as a visual alarm in case one has changed the configuration settings but has not yet saved the new values in the product). For added security the ATyS g may be equipped with a sealable cover so as to limit the access to configuration settings. Refer to the product accessory section for details.

### 1 Set Dip Dip Switch Setting Options

SET the 4 Dip Switches using a small screw driver. Possible variants vary from positions "A to H" as described in the table below. For convenience, the position functions are also described on the front of the ATS controller adjacent to the dip switches.

**Note:** The READY LED will flash green as soon as settings are changed and until the new settings have been saved by pressing the PROG OK button momentarily.

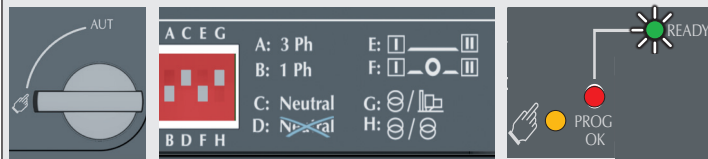

#### Dip Switch Setting Options

Dipswitch	Position	Function
Dipswitch 1 A / B	A	Three Phase Network
	B	Single Phase Network (Attn : Dipswitch 2 is inactive in this position)
Dipswitch 2 C / D	C	Three Phase 4 wire Network (Including Neutral) (Allows to detect a loss of neutral for unbalanced loads)
	D	Three Phase 3 wire Network (Without Neutral)
Dipswitch 3 E / F	E	Load supply down time of 0 second (ODT = 0 sec)
	F	Load supply down time of 2 seconds (ODT = 2 sec)
Dipswitch 4 G / H	G	Main - Generator Application
	H	Main - Main Application

### 2 Set Pot Potentiometer Setting Options

SET the 4 potentiometers using a small screw driver paying attention to the arrow indicating the position. There are a total of 14 positions for which the specific settings are described in the table below.

**Note:** The READY LED will flash green as soon as settings are changed and until the new settings have been saved by pressing the PROG OK button momentarily.



**WARNING** Whatever Pot 1 trimming, it is IMPERATIVE to set Pots 2 to 4.

Potentiometer	Configuration														
Un	Position	Auto Conf	1	2	3	4	5	6	7	8	9	10	11	12	13
	PP / PN	Measured	127V	220V	230V	240V	277V	120V	127V	132V	138V	220V	230V	240V	277V
	F	50Hz	60Hz												
ΔU/ΔF	Position	1	2	3	4	5	6	7	8	9	10	11	12	13	14
	U threshold in % of Un	5%	6%	7%	8%	9%	10%	11%	12%	13%	14%	15%	16%	18%	20%
FT	F threshold in % of Fn	3%	3%	4%	4%	5%	5%	6%	6%	7%	7%	8%	8%	9%	10%
	Hysteresis	20% of ΔU/ΔF settings													
RT	Source Failure Timer (s)	0	1	2	3	4	5	8	10	15	20	30	40	50	60
	Source Return Timer (min)	0	1	2	3	4	5	8	10	15	20	30	40	50	60

### Press 3 >2s Auto Configuration of Mains Voltage and Frequency

If the 1st potentiometer is not on "Auto Conf", go to STEP 4.

The ATyS g includes an "Auto Configuration" feature to detect the mains voltage and frequency nominal values, phase rotation and neutral position and saves them in the ATS controller.

**Note:** Before configuring the nominal values ensure that the product is properly wired, verified and ready for commissioning. It is imperative that the network supply is available and that the wiring to the ATyS g voltage sensing terminals 103 – 106 and 203 – 206 has been done. It is preferable to use the ATyS sensing kit that may be provided as an accessory.

• Press and hold the Red "PROG OK" button for >2s to measure the mains voltage and frequency.

**Note:** The source available LED will flash while the available network is being measured. The READY LED will flash green as soon as settings are measured and until these settings have been saved by pressing the PROG OK button a second time momentarily. (Refer to STEP 4).

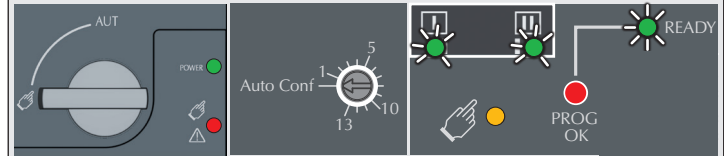

### Press 4 <60ms Saving the configured values

To SAVE the recorded setting configuration press the PROG OK button momentarily: <60ms.

**Note:** The flashing READY LED goes off once the values are saved in the ATS controller.

At least one of the source availability LED must be ON.

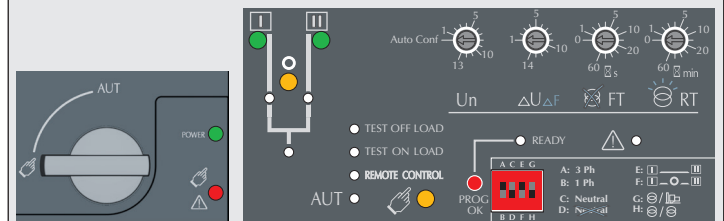

### AUT Ready! Putting the ATyS g into Auto Operation

After following Steps 1 to 4, and once ready to put the ATyS g into AUTO operation turn the mode selector switch to Auto.

**Note:** When the product is powered and properly configured, after switching the product from Manual Mode to Auto Mode the READY light should be a steady green light

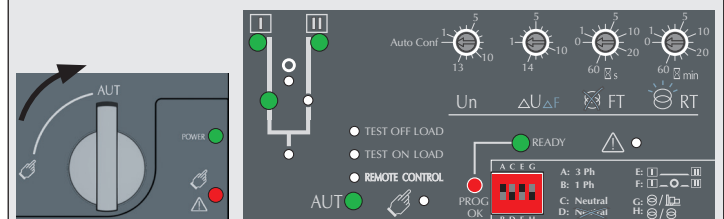

**WARNING** Depending on the state of the ATyS g the ATS automation may change the switch position as soon as the mode selector is switched to AUT. This is a normal operation.

- MANUAL Mode LED indication. (Yellow steady light when in Manual Mode).
- AUTO Mode LED indication. Green steady light when in Auto mode with no timers running. Green flashing light when in Auto with timers running in the background.
- REMOTE CONTROL Mode LED indication. Yellow steady light when in remote control mode. Remote control mode is achieved with the Auto/Manu selector switched to Auto and terminals 312 closed with terminal 317. Remote control orders are received through closing 314 to 316 with 317.
- TEST ON LOAD CONTROL Mode LED indication. (Yellow steady light when in TON mode)
- TEST OFF LOAD CONTROL Mode LED indication. (Yellow steady light when in TOF mode).
- Switch 1 LED position indication. (Green when in position 1).
- Source supply I availability LED indication. (Green when supply I voltage is within the set limits).
- Zero position LED indication. (Yellow when in position 0).
- Switch 2 LED position indication. (Green when in position 2).
- Source supply II availability LED indication. (Green when supply II voltage is within the set limits).
- Sealing screw location 1 for use with sealing cover (Available as an accessory)
- Potentiometer 1 : Network Configuration. (Auto Configuration or refer to the configuration guide sticker on the front of the ATyS g when using the predefined setting positions 1 to 13).
- Potentiometer 2 : Voltage and Frequency threshold settings. (Refer to the configuration guide sticker on the front of the ATyS g to set the V / Hz threshold. Positions 1 to 14).
- Potentiometer 3: Supply FAILURE Time (FT) Adjustable from 0 to 60 seconds.
- Potentiometer 4: Supply RETURN Time (RT) Adjustable from 0 to 60 minutes.
- READY LED indication. Green steady light : Product in AUTO, Watchdog OK, Product Available to chgover. Green flashing: Settings displayed not saved or have been changed since last saved. (Press PROG OK button in manual mode to save or revert to last saved settings).

- Sealing screw location 2 for use with the sealing cover.
- FAULT LED indication. (Red steady light in case of an ATS controller internal fault).
- Configuration dip switches : (4 dip switches with 2 positions in each A to H).
- PROG OK: Configuration save push button. (ATTN: Active in Manual Mode ONLY). Press briefly to confirm and save all set configuration settings. Hold pressed for 2 seconds to set the network supply voltage and frequency by Auto Configuration. This is to be followed by pressing briefly to save the set value configured.
- Green LED Indication: Power
- Red LED Indication: Product Unavailable / Manual Mode / Fault Condition
- Auto / Manual mode selector switch (Key version available as an option)
- Padlocking facility (Up to 3 padlocks of dia. 4 – 8 mm)
- Emergency manual operation shaft location (Accessible only in manual mode)
- Switch position indication window: 1 (On switch I) 0 (Off I) 0 (Off II) (On switch II).

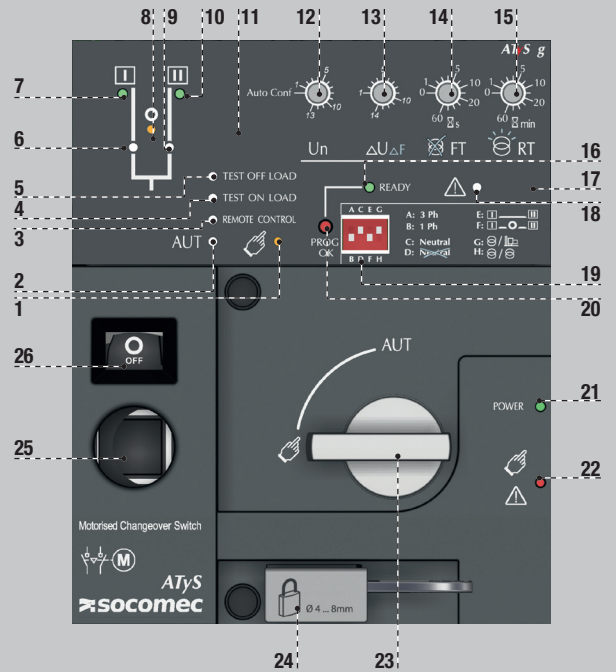

### STEP 7A AUT Mode (Automatic Control)



Ensure that the emergency handle is not inserted in the product and turn the mode selector to the AUT position. LED "Power" Green: ON. LED Manual/Default: OFF

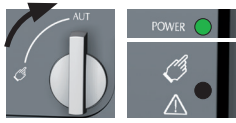

### STEP 7B AUT Mode (Remote Control)

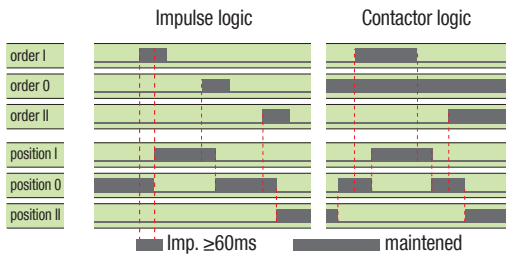

To enable control, close contact 312 with 317. For contactor logic bridge contact 316 with 317. To operate: close the contact corresponding to the desired position. To force the product to 0 position "OFF" bridge contact 313 with 317.

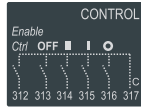

### Dimensions in./mm.

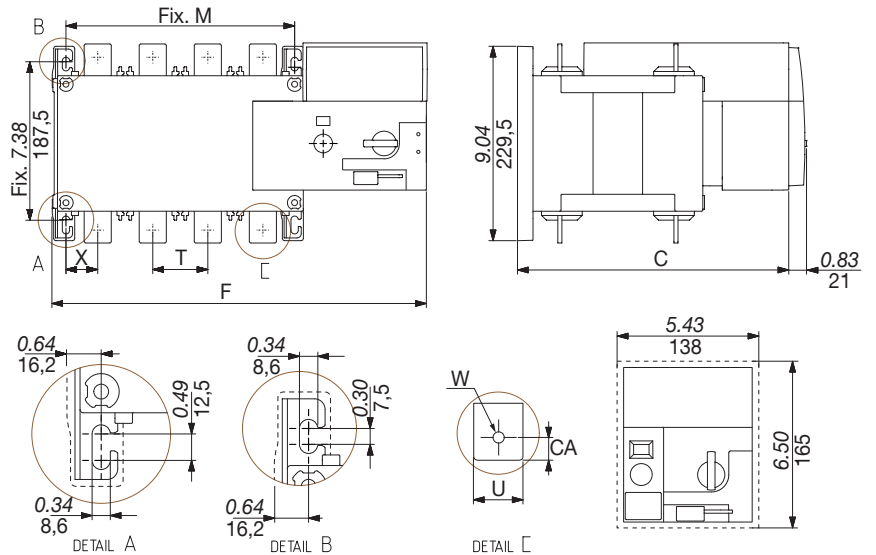

### STEP 7C Manual Operation

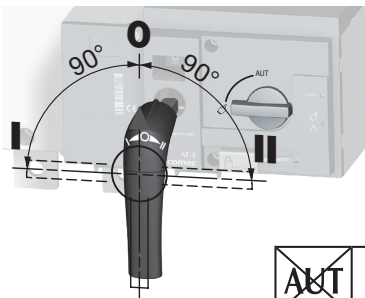

### STEP 7D Padlocking Mode (as standard : in position 0)



	125 A		160 A		200 A		250 A		315 A		400 A		500 A		630 A	
	3 P	4 P	3 P	4 P	3 P	4 P	3 P	4 P	3 P	4 P	3 P	4 P	3 P	4 P	3 P	4 P
	in	mm	in	mm	in	mm	in	mm	in	mm	in	mm	in	mm	in	mm
C	9.61	244	9.61	244	9.61	244	9.61	244	9.61	244	9.61	244	12.64	321	12.64	321
CA	0.39	10	0.39	10	0.39	10	0.39	10	0.39	10	0.39	10	0.59	15	0.59	15
F	11.28	286,5	12.48	317	11.28	286,5	12.48	317	11.28	286,5	12.48	317	12.91	328	14.88	378
M	4.72	120	5.91	150	4.72	120	5.91	150	4.72	120	5.91	150	6.30	160	8.27	210
T	1.42	36	1.42	36	1.42	36	1.42	36	1.42	36	1.42	36	1.97	50	1.97	50
U	0.79	20	0.79	20	0.79	20	0.79	20	0.79	20	0.79	20	0.98	25	0.98	25
W	0.35	9	0.35	9	0.35	9	0.35	9	0.35	9	0.35	9	0.43	11	0.43	11
X	1.10	28	0.87	22	1.10	28	0.87	22	1.10	28	0.87	22	1.30	33	1.30	33

	315 A		400 A		500 A		630 A		800 A		1000 A	
	3 P	4 P	3 P	4 P	3 P	4 P	3 P	4 P	3 P	4 P	3 P	4 P
	in	mm	in	mm	in	mm	in	mm	in	mm	in	mm
C	9.61	244	9.61	244	9.61	244	12.64	321	12.64	321	12.64	321
CA	0.59	15	0.59	15	0.59	15	0.59	15	0.59	15	0.79	20
F	12.91	328	14.88	378	12.91	328	14.88	378	14.84	377	17.20	437
M	6.30	160	8.27	210	6.30	160	8.27	210	8.27	210	10.63	270
T	1.97	50	1.97	50	1.97	50	2.56	65	2.56	65	2.56	65
U	1.38	35	1.38	35	1.38	35	1.26	32	1.26	32	1.77	45
W	0.43	11	0.43	11	0.43	11	0.55	14	0.55	14	0.51	13
X	1.30	33	1.30	33	1.30	33	1.67	42,5	1.48	37,5	1.67	42,5